

## 650V N-Channel Multi-EPI Super-JMOSFET

### General Description

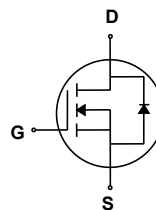
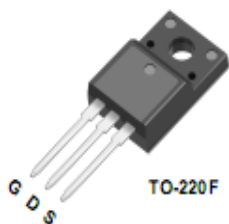
This Power MOSFET is produced using Silkor's Advanced Super-Junction technology.

This advanced technology has been especially tailored to minimize conduction loss, provide superior switching performance, and withstand high energy pulse in the avalanche and commutation mode.

These devices are well suited for AC/DC power conversion in switching mode operation for higher efficiency.

### Features

- 15A, 650V,  $R_{DS(on)max} = 0.28\Omega @ V_{GS} = 10V$
- Low gate charge ( typical 19.6nC)
- Lower Gate Resistance
- 100% Avalanche Tested
- Pb-free and RoHS Compliant



### Absolute Maximum Ratings

$T_C = 25^\circ\text{C}$  unless otherwise noted

| Symbol         | Parameter   | SL15N60CF   | Units               |
|----------------|---|-------------|---------------------|
| $V_{DSS}$      | Drain-Source Voltage  | 650         | V                   |
| $I_D$          | Drain Current - Continuous ( $T_C = 25^\circ\text{C}$ )<br>- Continuous ( $T_C = 100^\circ\text{C}$ ) | 15          | A                   |
|                |   | 8           | A                   |
| $I_{DM}$       | Drain Current - Pulsed (Note 1)   | 45          | A                   |
| $V_{GSS}$      | Gate-Source Voltage   | $\pm 30$    | V                   |
| EAS            | Single Pulsed Avalanche Energy (Note 2)   | 710         | mJ                  |
| $I_{AR}$       | Avalanche Current (Note 1)  | 3.0         | A                   |
| $E_{AR}$       | Repetitive Avalanche Energy   | 1.11        | mJ                  |
| dv/dt          | Peak Diode Recovery dv/dt (Note 3)  | 20          | V/ns                |
|                | MOSFET dv/dt  | 100         |                     |
| $P_D$          | Power Dissipation ( $T_C = 25^\circ\text{C}$ )<br>- Derate above $25^\circ\text{C}$                   | 30          | W                   |
|                |   | 0.24        | W/ $^\circ\text{C}$ |
| $T_J, T_{STG}$ | Operating and Storage Temperature Range   | -55 to +150 | $^\circ\text{C}$    |
| $T_L$          | Maximum lead temperature for soldering purposes, 1/8" from case for 5 seconds                         | 300         | $^\circ\text{C}$    |

\* Drain current limited by maximum junction temperature.

### Thermal Characteristics

| Symbol          | Parameter                               | SL15N60CF | Units                     |
|-----------------|---|-----------|---------------------------|
| $R_{\theta JC}$ | Thermal Resistance, Junction-to-Case    | 4.1       | $^\circ\text{C}/\text{W}$ |
| $R_{\theta JS}$ | Thermal Resistance, Case-to-Sink Typ.   | --        | $^\circ\text{C}/\text{W}$ |
| $R_{\theta JA}$ | Thermal Resistance, Junction-to-Ambient | 62.5      | $^\circ\text{C}/\text{W}$ |

## Electrical Characteristics

$T_C = 25^\circ\text{C}$  unless otherwise noted

| Symbol                     | Parameter                          | Test Conditions   | Min | Typ | Max  | Units |
|----------------------------|------------------------------------|---|-----|-----|------|-------|
| <b>Off Characteristics</b> |                                    |   |     |     |      |       |
| BV <sub>DSS</sub>          | Drain-Source Breakdown Voltage     | $V_{GS} = 0\text{ V}, I_D = 250\text{mA}$                           | 650 | --  | --   | V     |
|                            |                                    | $V_{GS} = 0\text{ V}, I_D = 0.25\text{uA}, T_J = 150^\circ\text{C}$ | 650 | --  | --   |       |
| I <sub>DSS</sub>           | Zero Gate Voltage Drain Current    | $V_{DS} = 600\text{ V}, V_{GS} = 0\text{ V}$                        | --  | --  | 1    | uA    |
|                            |                                    | $V_{DS} = 480\text{ V}, T_C = 125^\circ\text{C}$                    | --  | 2   | --   | uA    |
| I <sub>GSSF</sub>          | Gate-Body Leakage Current, Forward | $V_{GS} = 30\text{ V}, V_{DS} = 0\text{ V}$                         | --  | --  | 100  | nA    |
| I <sub>GSSR</sub>          | Gate-Body Leakage Current, Reverse | $V_{GS} = -30\text{ V}, V_{DS} = 0\text{ V}$                        | --  | --  | -100 | nA    |

## On Characteristics

|                     |                                   |  |     |     |     |    |
|---------------------|-----------------------------------|--|-----|-----|-----|----|
| V <sub>GS(th)</sub> | Gate Threshold Voltage            | $V_{DS} = V_{GS}, I_D = 250\text{uA}$      | 2.5 | --  | 4.5 | V  |
| R <sub>DS(on)</sub> | Static Drain-Source On-Resistance | $V_{GS} = 10\text{ V}, I_D = 7.5\text{ A}$ | --  | 238 | 280 | mΩ |
| R <sub>g</sub>      | Gate resistance                   | F=1MHZ                                     | --  | 1.1 | --  | Ω  |

## Dynamic Characteristics

|                    |                                   |   |    |     |    |    |
|--------------------|-----------------------------------|---|----|-----|----|----|
| C <sub>iss</sub>   | Input Capacitance                 | $V_{DS} = 400\text{ V}, V_{GS} = 0\text{V},$<br>$f = 1\text{MHz}$ | -- | 780 | -- | pF |
| C <sub>oss</sub>   | Output Capacitance                |   | -- | 23  | -- | pF |
| C <sub>o(tr)</sub> | Time Related Output Capacitance   | $V_{DS} = 0\text{V to } 400\text{ V}, V_{GS} = 0\text{ V}$        | -- | 300 | -- | pF |
| C <sub>o(er)</sub> | Energy Related Output Capacitance |   | -- | 37  | -- | pF |

## Switching Characteristics

|                     |                     |   |    |      |    |    |
|---------------------|---------------------|---|----|------|----|----|
| t <sub>d(on)</sub>  | Turn-On Delay Time  | $V_{DS} = 400\text{ V}, I_D = 5.3\text{A}$<br>$V_{GS} = 10\text{ V}, R_G = 10\ \Omega$<br>See Figure 13 | -- | 7.6  | -- | ns |
| t <sub>r</sub>      | Turn-On Rise Time   |   | -- | 6.7  | -- | ns |
| t <sub>d(off)</sub> | Turn-Off Delay Time |   | -- | 38.2 | -- | ns |
| t <sub>f</sub>      | Turn-Off Fall Time  |   | -- | 8.4  | -- | ns |
| Q <sub>g</sub>      | Total Gate Charge   | $V_{DS} = 400\text{ V}, I_D = 5.3\text{A},$<br>$V_{GS} = 10\text{ V}$                                   | -- | 19.6 | -- | nC |
| Q <sub>gs</sub>     | Gate-Source Charge  |   | -- | 3.7  | -- | nC |
| Q <sub>gd</sub>     | Gate-Drain Charge   |   | -- | 9.7  | -- | nC |

## Drain-Source Diode Characteristics and Maximum Ratings

|                 |   |  |    |     |     |    |
|-----------------|---|--|----|-----|-----|----|
| I <sub>S</sub>  | Maximum Continuous Drain-Source Diode Forward Current | --   | -- | 15  | A   |    |
| I <sub>SM</sub> | Maximum Pulsed Drain-Source Diode Forward Current     | --   | -- | 45  | A   |    |
| V <sub>SD</sub> | Drain-Source Diode Forward Voltage                    | $V_{GS} = 0\text{ V}, I_S = 5.3\text{A}$                                     | -- | --  | 1.2 | V  |
| t <sub>rr</sub> | Reverse Recovery Time                                 | $V_{DD} = 400\text{ V}, I_S = 5.3\text{A},$<br>$di_F / dt = 100\text{ A/us}$ | -- | 234 | --  | ns |
| Q <sub>rr</sub> | Reverse Recovery Charge                               |  | -- | 2.2 | --  | uC |

### ※Notes:

1. Repetitive rating: pulse-width limited by maximum junction temperature.
2.  $L=79\text{mH}, I_{AS} = 3\text{ A}, R_G = 25\ \Omega$ , starting  $T_J = 25^\circ\text{C}$ .
3.  $I_{SD} \leq 5.3\text{ A}, di/dt \leq 100\text{ A}/\mu\text{s}, V_{DD} \leq 400\text{ V}$ , starting  $T_J = 25^\circ\text{C}$ .

## Typical Characteristics

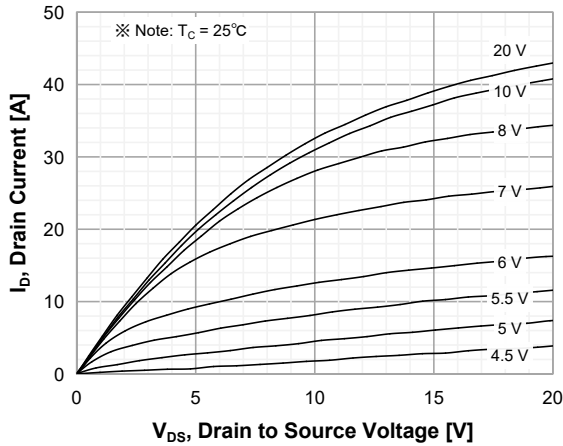


Figure 1. On-Region Characteristics

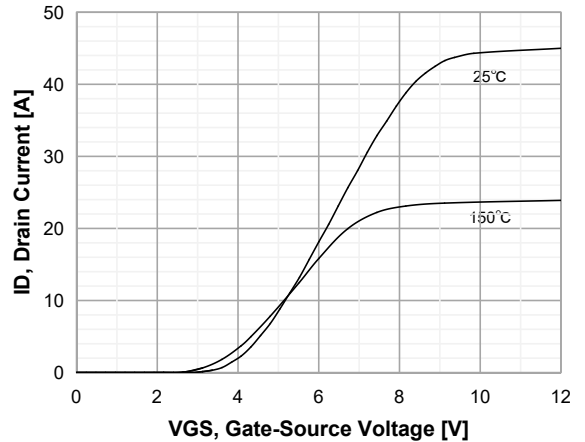


Figure 2. Transfer Characteristics

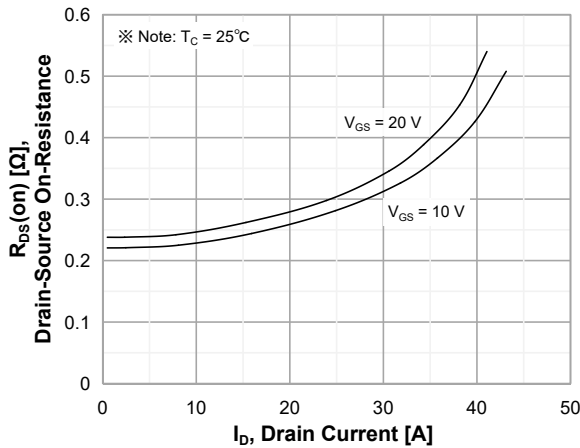


Figure 3. On-Resistance Variation vs Drain Current and Gate Voltage

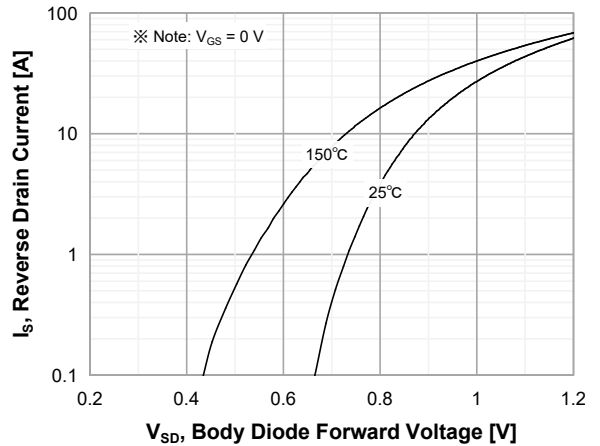


Figure 4. Body Diode Forward Voltage Variation with Source Current and Temperature

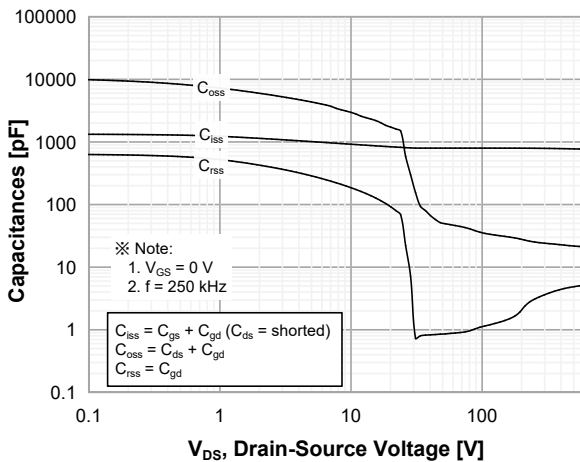


Figure 5. Capacitance Characteristics

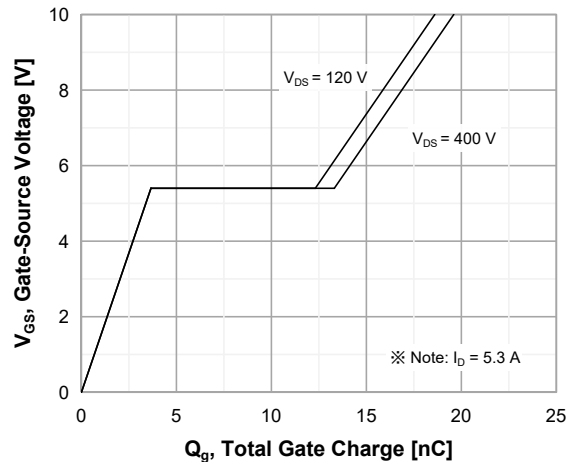
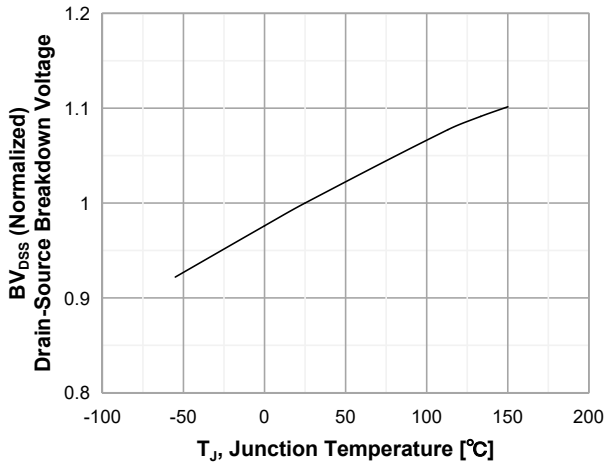
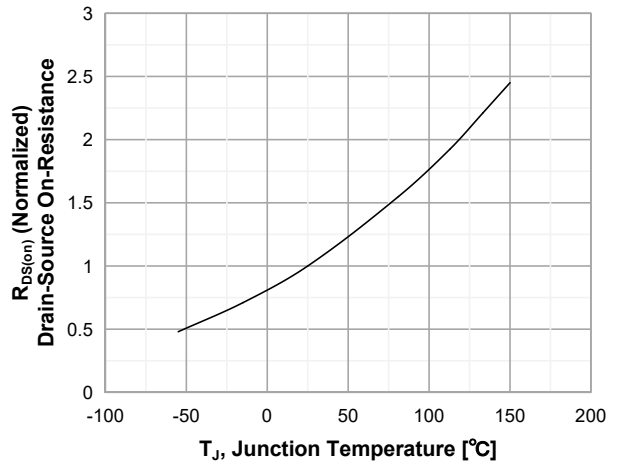


Figure 6. Gate Charge Characteristics

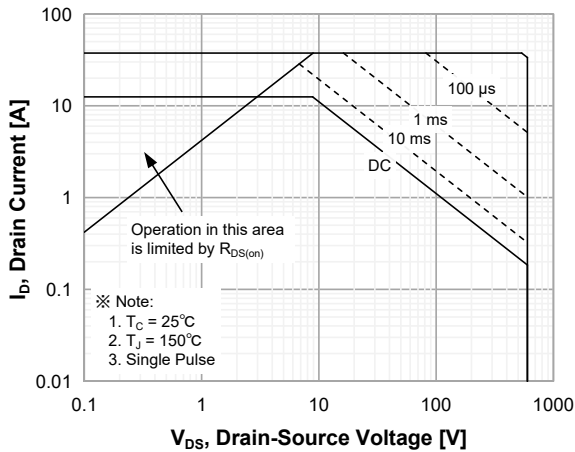
**Typical Characteristics (Continued)**



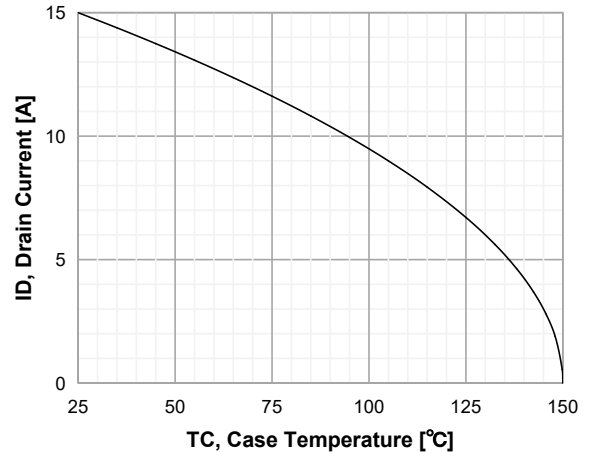
**Figure 7. Breakdown Voltage Variation vs Temperature**



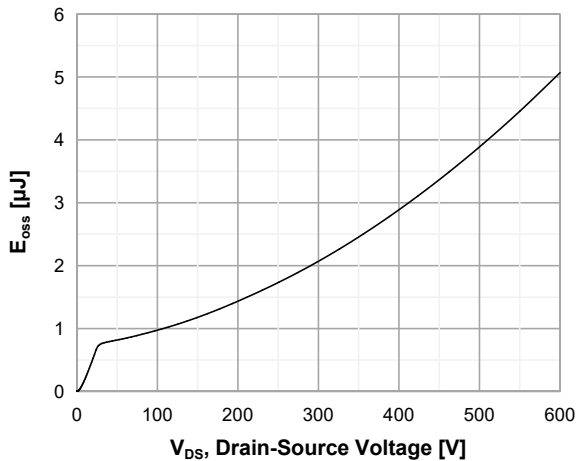
**Figure 8. On-Resistance Variation vs Temperature**



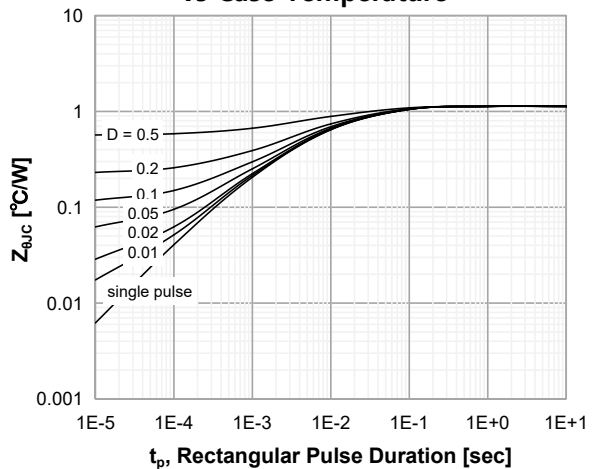
**Figure 9. Maximum Safe Operating Area**



**Figure 10. Maximum Drain Current vs Case Temperature**

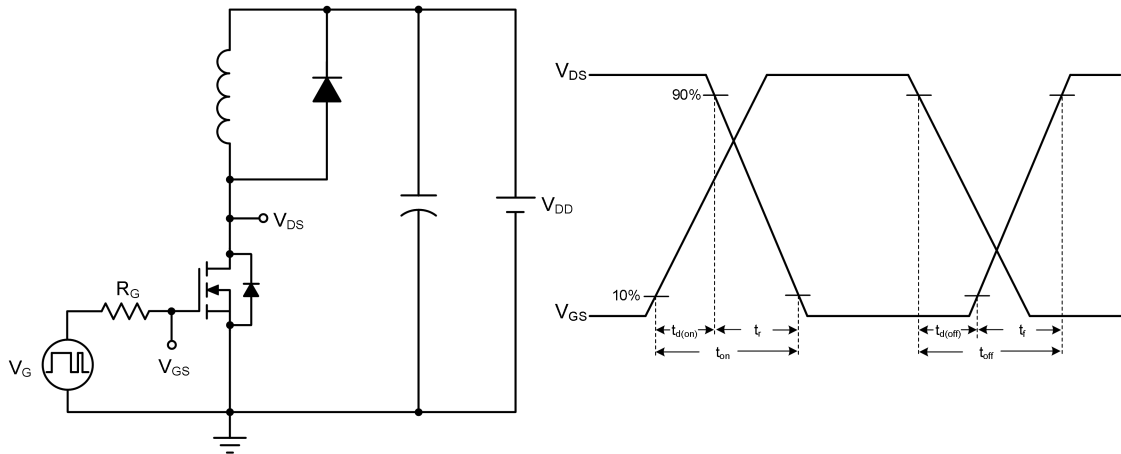


**Figure 11.  $E_{OSS}$  vs. Drain to Source Voltage**

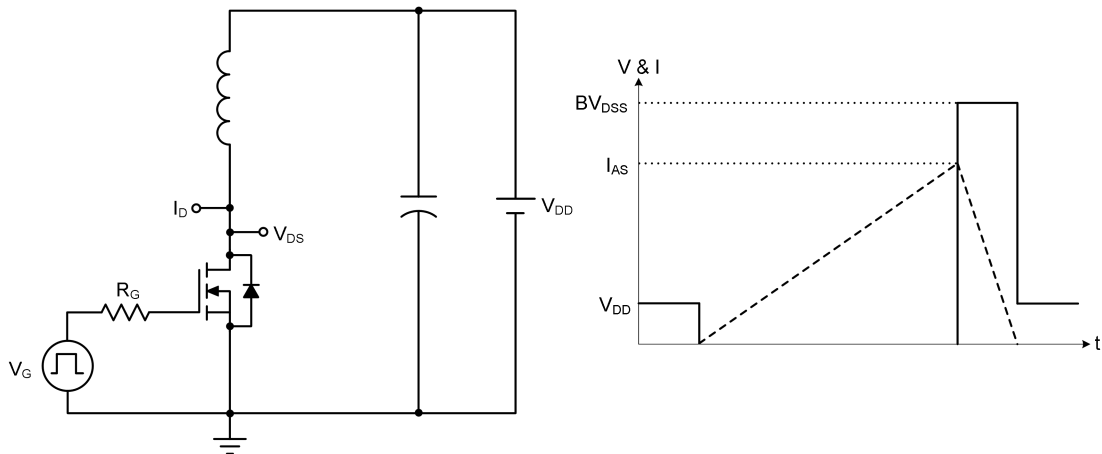


**Figure 12. Transient Thermal Response Curve**

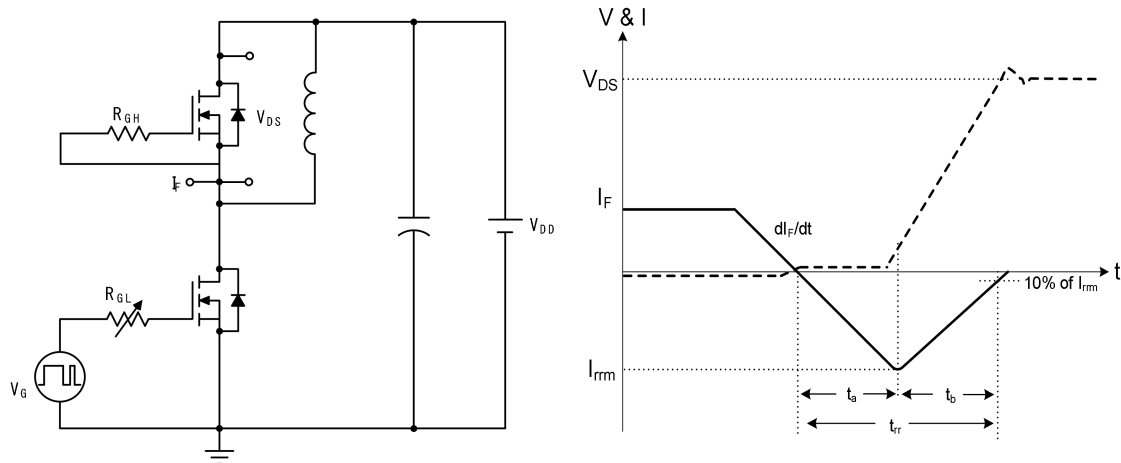
## Inductive Load Switching Test Circuit and Waveforms



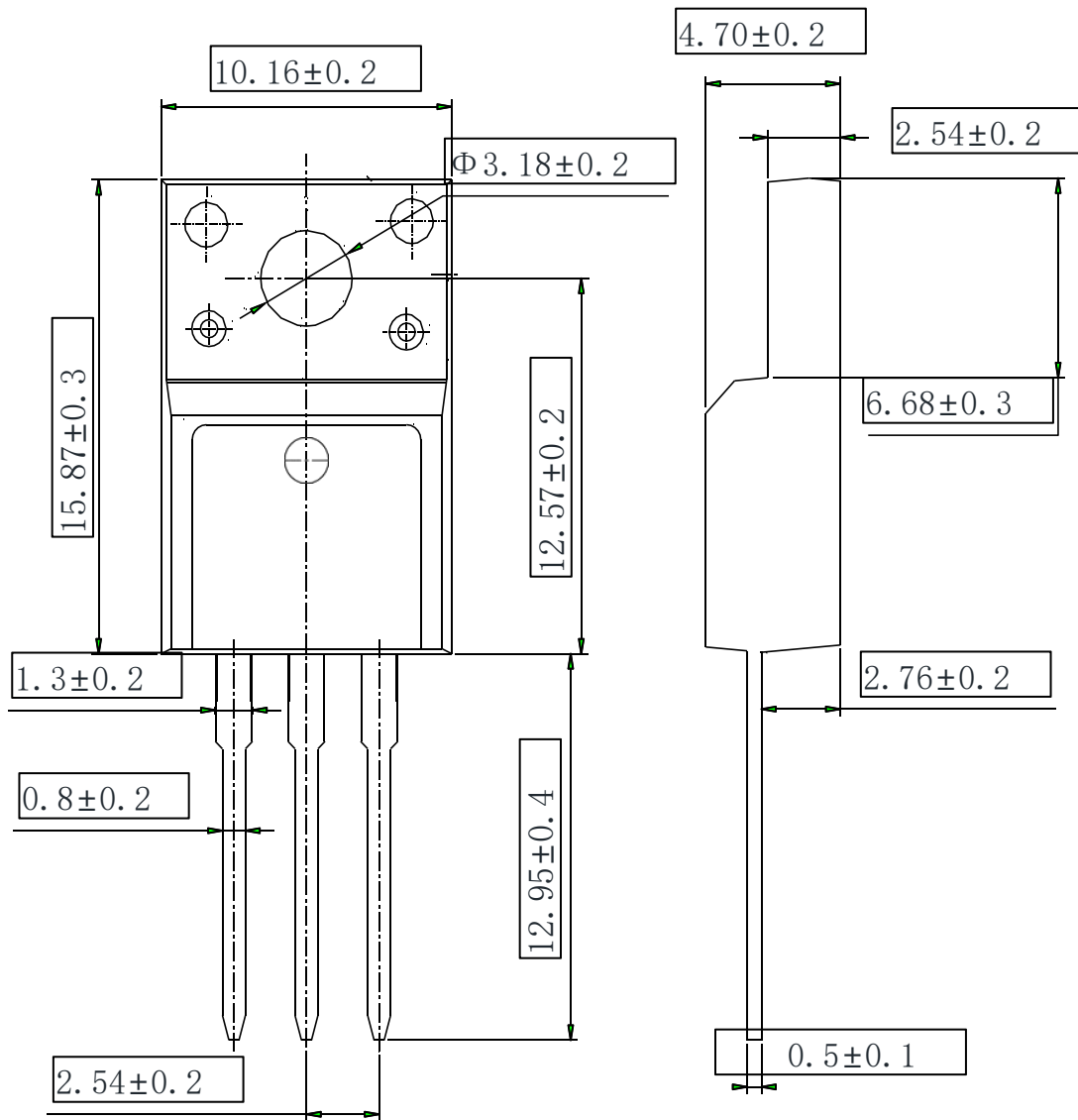
## Unclamped Inductive Switching Test Circuit & Waveforms



## Peak Diode Recovery dv/dt Test Circuit and Waveforms



**TO-220F OUTLINE**



**NOTE:**

1. The plastic package is not marked as smooth surface  $R_a=0.1$ ; Subglossy surface  $R_a=0.8$
2. Undeclared tolerance  $\pm 0.15$ , Unmarked fillet  $R_{max}=0.25$